

SmartKing™

SKDC115112 INSTALLATION INSTRUCTIONS ADJUSTABLE FORCE: EN2 TO EN6

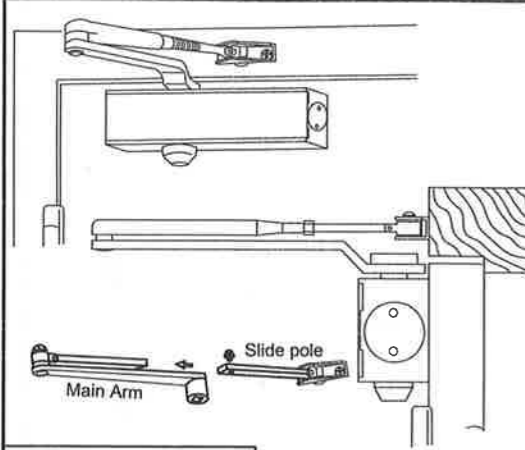

Regular installation

1 Please choose the way you want to install, and drilling a centre hole according to the drawing.

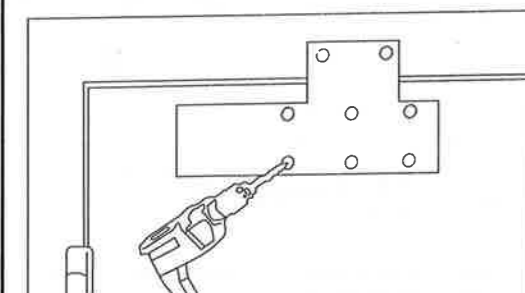

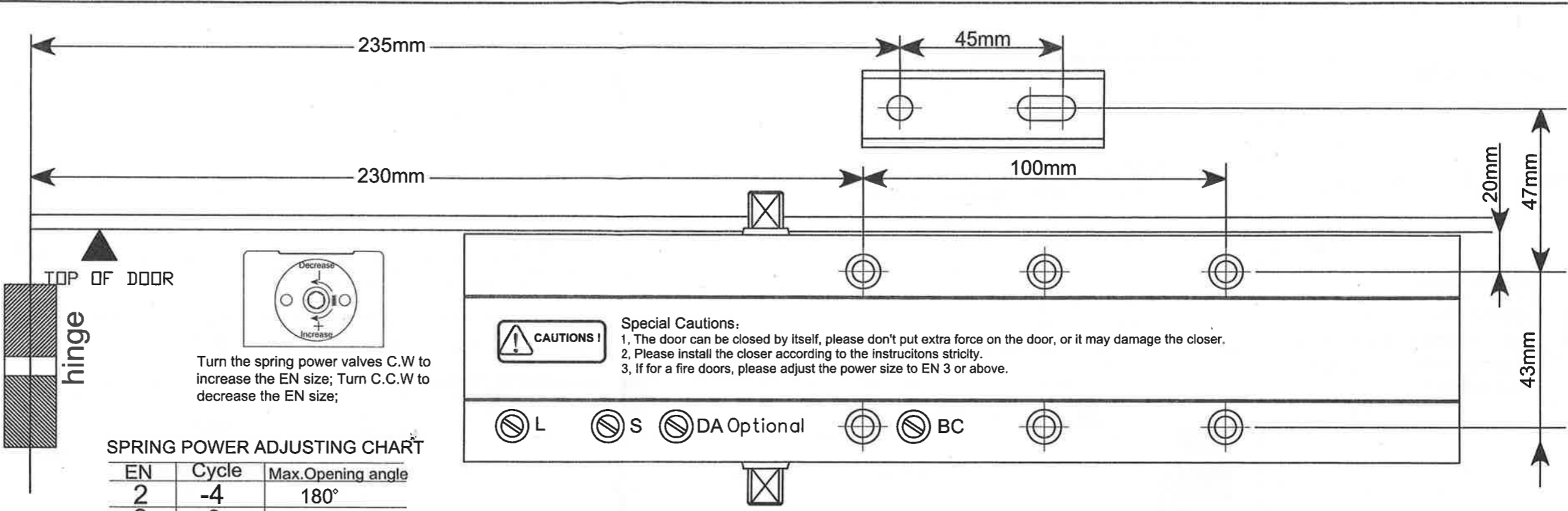

CAUTIONS! Special Cautions:
 1. The door can be closed by itself, please don't put extra force on the door, or it may damage the closer.
 2. Please install the closer according to the instructions strictly.
 3. If for a fire doors, please adjust the power size to EN 3 or above.

Turn the spring power valves C.W to increase the EN size; Turn C.C.W to decrease the EN size;

SPRING POWER ADJUSTING CHART

EN	Cycle	Max. Opening angle
2	-4	180°
3	0	180°
4	+4	180°
5	+8	180°
6	+12	180°

Noted: The closers preset EN3 when out of factory.

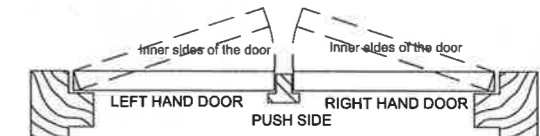

2 Please install the closer body on the door according to the drawing, and then please make sure the adjusting power size valves towards to the hinges.

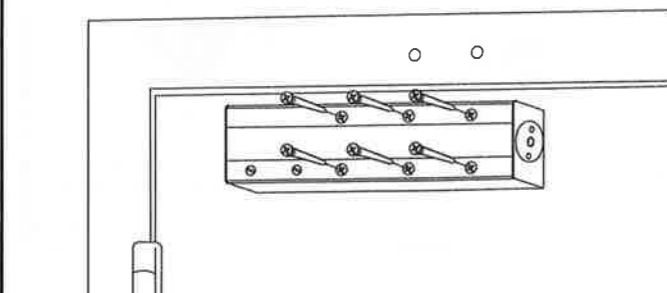

3 1. Disassemble the forarm and main arm (If it's a screw pipe forarm, please disassemble from the elbow of the arm, if it's a slide pole arm, just disassemble the slide pole is ok).
 2. Fix the forarm on the frame according to the drawing.

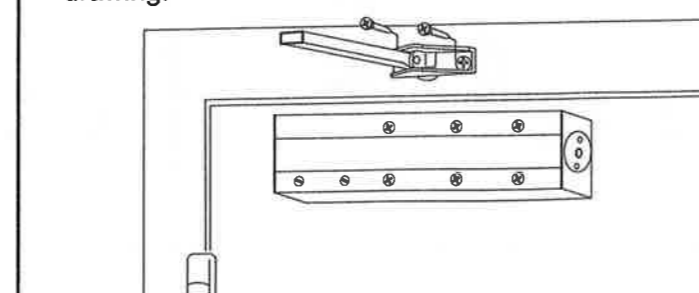

4 1. Put the main arm on the upper shaft then turn the main arm to meet the forarm, make sure the forarm vertical to the door all the time.
 2. Adjusting the length of the forarm (screw pipe arm) or insert the slide pole (slide pole arm) into the main arm slot and connect the main arm.

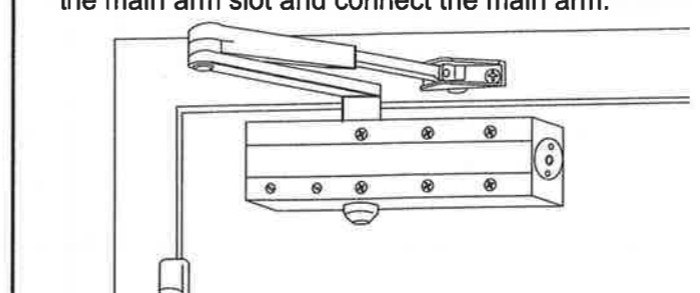

5 Adjusting the closing (S), Latching (L) speed, and BC, DA (optional) speed.

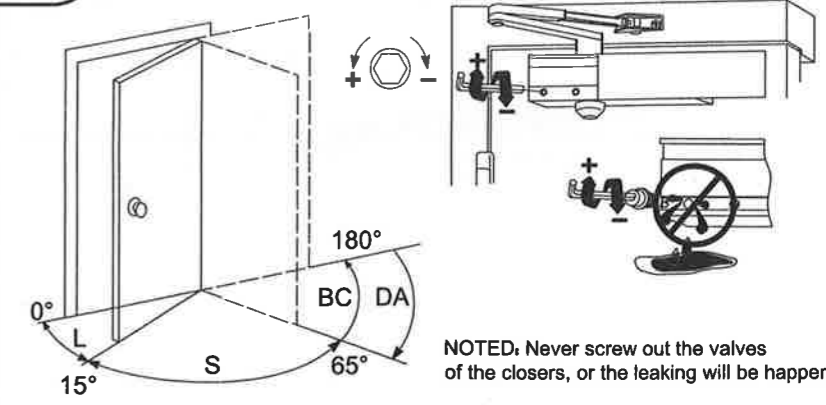

NOTED: Never screw out the valves of the closers, or the leaking will be happen.

SmartKing™

SKDC115112 INSTALLATION INSTRUCTIONS ADJUSTABLE FORCE: EN2 TO EN6

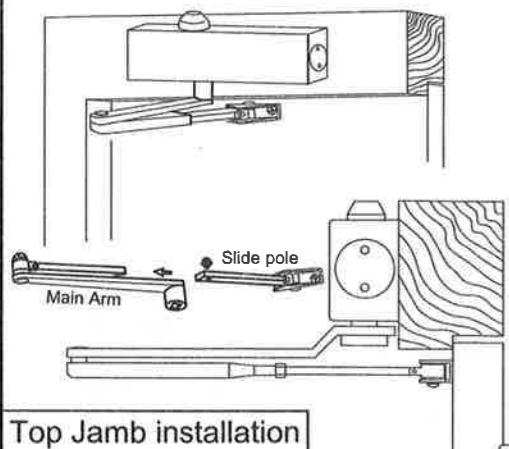

Top Jamb installation

1 Please choose the way you want to install, and drilling a centre hole according to the drawing.

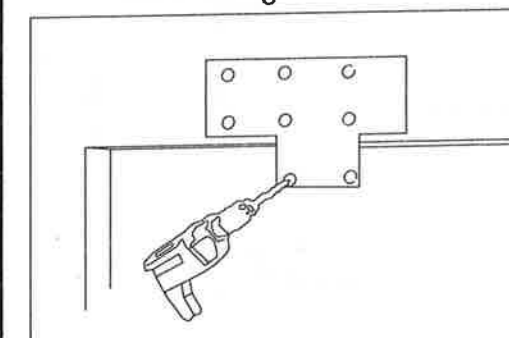

2 Please install the closer body on the door jamb according to the drawing, and then please make sure the adjusting power size valves towards to the hinges.

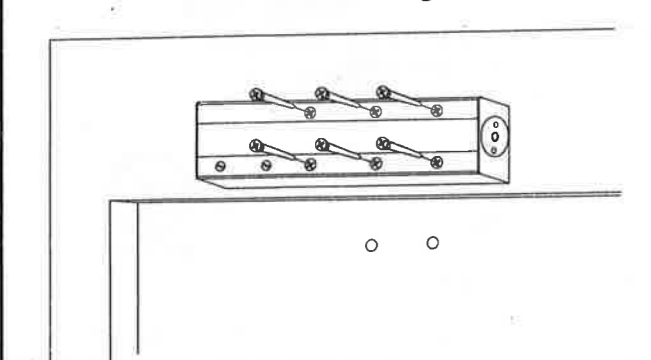

Turn the spring power valves C.W to increase the EN size; Turn C.C.W to decrease the EN size;

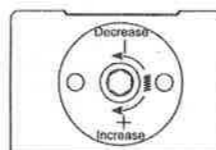

SPRING POWER ADJUSTING CHART

EN	Cycle	Max. Opening angle
2	-4	180°
3	0	180°
4	+4	180°
5	+8	180°
6	+12	180°

Noted: The closers preset EN3 when out of factory.



Special Cautions:

1. The door can be closed by itself, please don't put extra force on the door, or it may damage the closer.
2. Please install the closer according to the instructions strictly.
3. If for a fire doors, please adjust the power size to EN 3 or above.

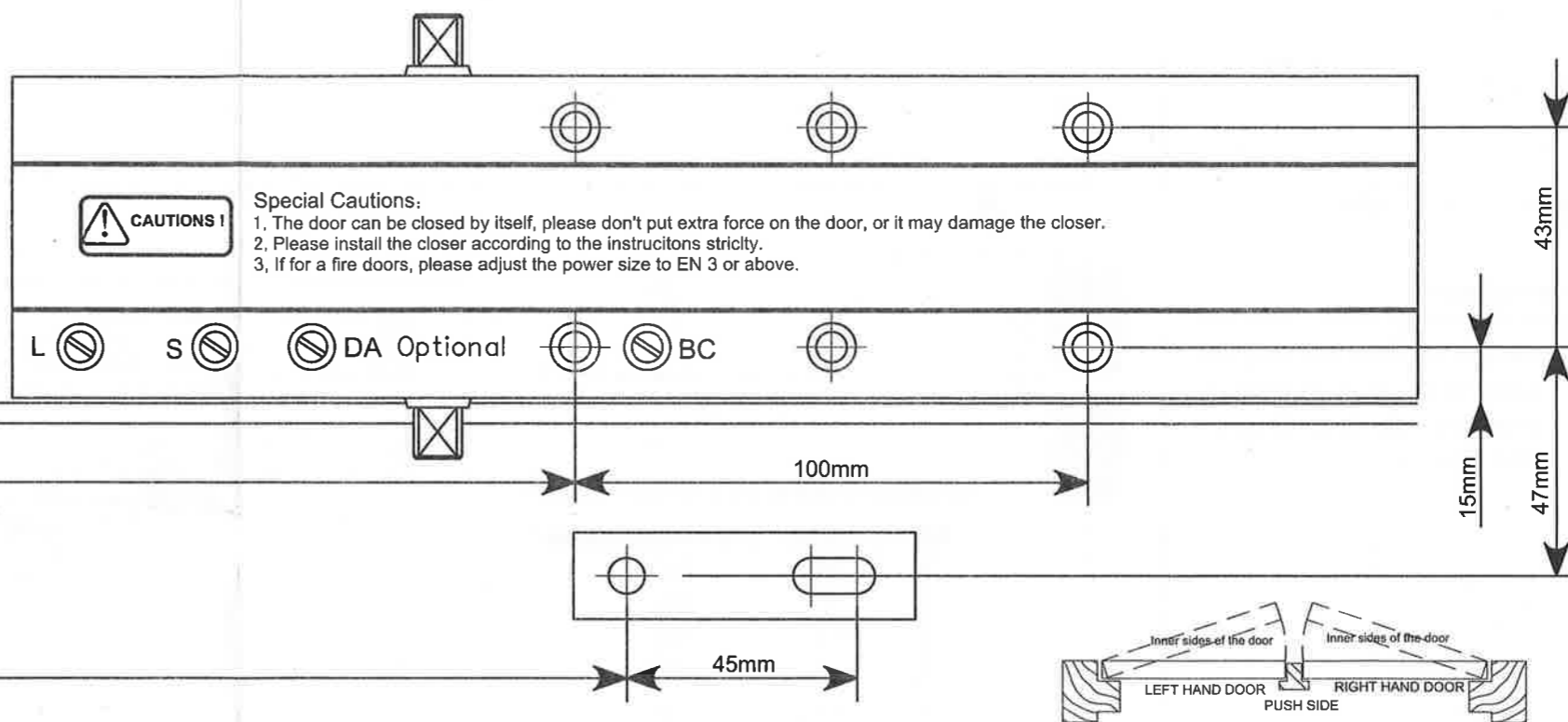

4 1. Put the main arm on the under shaft then turn the main arm to meet the forarm, make sure the forarm vertical to the door all the time.
2. Adjusting the length of the forarm (screw pipe arm) or insert the slide pole (slide pole arm) into the main arm slot and connect the main arm.

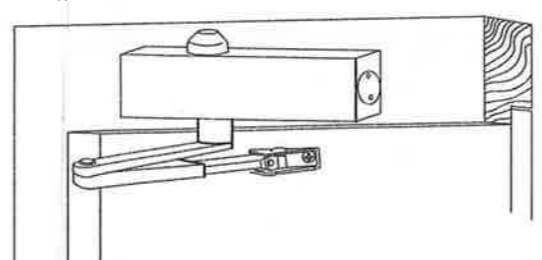

5 Adjusting the closing (S), Latching (L) speed, and BC, DA (optional) speed.

